



website <http://www.lgservice.com>
e-mail <http://www.lgeservice.com/techsup.html>

LG Window-Type Air Conditioner

LG

OWNER'S MANUAL

**MODELS: LC6000, LC8000
LC1000, LC1200**

ENGLISH

FRANÇAIS

ESPAÑOL

IMPORTANT

Please read through this manual. It contains valuable information about your air conditioner. This manual may help save time and money by explaining proper air conditioner maintenance and preventing improper use.

PRECAUTIONS

Pay close attention to precautions in order to prevent potential hazards and damage from misuse or improper installation. LG is not responsible for any damages caused by misuse of the air conditioner.

TABLE OF CONTENTS

1. Safety Precautions

2. Operating Instructions

3. Care and Maintenance

4. Hardware Installation

5. Common Issues

For Your Records

Write the model and serial numbers here:

Model # _____

Serial # _____

You can find them on a label on the side of each unit.

Dealer's Name _____

Date Purchased _____

Read This Manual

Inside you will find many helpful hints on how to use and maintain your air conditioner properly. Just a little preventive care on your part can save you a great deal of time and money over the life of your air conditioner.



You'll find many answers to common problems in the chart of troubleshooting tips. If you review our chart of **Troubleshooting Tips** first, you may not need to call for service at all.





CAUTION



- Contact the authorized service technician for repair or maintenance of this unit.
- Contact the installer for installation of this unit.
- The air conditioner is not intended for use by young children or invalids without supervision.
- Young children should be supervised to ensure that they do not play with the air conditioner.















To prevent injury and property damage, follow these instructions. Incorrect operation due to ignoring instructions will cause harm or damage, the seriousness of which is indicated by the following symbols.

	WARNING This symbol shows the possibility of death or serious injury.
	CAUTION This symbol indicates the possibility of injury or damage to property.

	Never Do This
	Always Do This

■ The following items are classified by these symbols.

 **WARNING** 

<p> Plug in the power plug properly.</p>	<p> Do not operate or stop the unit by inserting or pulling out the power plug.</p>	<p> Do not damage or use an unspecified power cord.</p>
<ul style="list-style-type: none"> • Otherwise, it will cause electric shock or fire due to heat generation or electric shock. 	<ul style="list-style-type: none"> • It will cause electric shock or fire due to heat generation. 	<ul style="list-style-type: none"> • It will cause electric shock or fire. • If the supply cord is damaged, it must be replaced by the manufacturer or its service agent or a similarly qualified person in order to avoid a hazard. (Y attachment)
<p> Do not modify power cord length or share the outlet with other appliances.</p>	<p> Do not operate with wet hands or in damp environment.</p>	<p> Always plug into a grounded outlet.</p>
<ul style="list-style-type: none"> • It will cause electric shock or fire due to heat generation. 	<ul style="list-style-type: none"> • It will cause electric shock. 	<ul style="list-style-type: none"> • No grounding may cause electric shock (See Installation Manual).
<p> Do not allow water to run into electric parts.</p>	<p> Always install air leakage breaker and a dedicated switching board.</p>	<p> Unplug the unit if strange sounds, odors, or smoke comes from it.</p>
<ul style="list-style-type: none"> • It will cause failure of machine or electric shock. 	<ul style="list-style-type: none"> • No installation may cause fire and electric shock accident. 	<ul style="list-style-type: none"> • It may cause fire and electric shock accident.
<p> Do not use the socket if it is loose or damaged.</p>	<p> Do not open the entrance during operation.</p>	<p> Keep firearms away.</p>
<ul style="list-style-type: none"> • It may cause fire and electric shock. 	<ul style="list-style-type: none"> • It may cause electric shock. 	<ul style="list-style-type: none"> • It may cause fire.
<p> Do not use the power cord close to the heating tools.</p>	<p> Do not use the power cord near flammable gas or combustibles such as gasoline, benzene, thinner, etc.</p>	
<ul style="list-style-type: none"> • It may cause fire and electric shock. 	<ul style="list-style-type: none"> • It may cause an explosion or fire. 	

⚠ WARNING

ⓘ **Ventilate before operating air conditioner when gas goes out.**

- It may cause explosion, fire, and burn.

ⓘ **Do not disassemble or modify products randomly.**

- It may cause failure and electric shock.

⚠ CAUTION

ⓘ **Never touch the metal parts of the unit when removing the filter.**

- They are sharp and may cause injury.

ⓘ **Do not clean the air conditioner with water.**

- Water may enter the unit and degrade the insulation. It may cause an electric shock.

ⓘ **Ventilate well when used together with a stove, etc.**

- An oxygen shortage may occur.

ⓘ **When cleaning the unit, first make sure the power and breaker are turned off.**

- Since the fan rotates at high speed during operation, it may cause injury.

ⓘ **Do not put a pet or house plant where it will be exposed to direct air flow.**

- This could injure the pet or plant.

ⓘ **Do not use appliance for special purpose such as animals or vegetables, precision machine, or conservation of art articles.**

- It may cause damage of animals or vegetables or loss of property.

ⓘ **Stop operation in storm or hurricanes.**

- Operation with windows opened may cause wetting of indoor and soaking of household furniture.

ⓘ **Hold the plug by the head when taking it out.**

- It may cause electric shock and damage.

ⓘ **Turn off the main power switch when not using it for a long time.**

- It may cause failure of product or fire.

ⓘ **Do not place obstacles around the absorption inlet or output.**

- It may cause failure of appliance or accident.

ⓘ **Ensure that an installation console of the outdoor appliance is not damaged due to the use for a long time.**

- If leaving appliance damaged, there is concern of damage due to the falling of product.

ⓘ **Always insert the filters securely. Clean it every two weeks.**

- Operation without filters will cause failure.

ⓘ **Do not use strong detergent such as wax or thinner but use a soft cloth.**

- Appearance may be deteriorated due to change of product color or scratching of its surface.

ⓘ **Do not place heavy object on the power cord and take care so that the cord should not be pressed.**

- There is danger of fire or electric shock.

ⓘ **Do not drink water drained from air conditioner.**

- It contains containments and will make you sick.

ⓘ **If water enters the product, turn off the the power switch of the main body of appliance. Contact service center after taking the power-plug out from the socket.**

ⓘ **Do not direct airflow at room occupants only.**

- This could damage your health.

Preparing for operation

- 1 Contact an installation specialist for installation.
- 2 Plug in the power plug properly.
- 3 Do not share the same outlet with other appliances
- 4 Do not use an extension cord.
- 5 Do not start/stop operation by plugging/unplugging the power cord.
- 6 If cord/plug is damaged, replace only with an authorized part.

Usage

- 1 Being exposed to direct airflow for an extended period of time could be hazardous to your health. Do not expose occupants, pets, or plants to direct airflow for extended periods of time.
- 2 Due to the possibility of oxygen deficiency, ventilate the room when used together with stoves or other heating devices.
- 3 Do not use this air conditioner for non-specified special purposes (e.g. preserving precision devices, food, pets, plants, and art objects). Usage in such a manner could harm such property.

Cleaning and maintenance

- 1 Do not touch the metal parts of the unit when removing the filter. Injuries can occur when handling sharp metal edges.
- 2 Do not use water to clean inside the air conditioner. Exposure to water can destroy the insulation, leading to possible electric shock.
- 3 When cleaning the unit, first make sure that the power and breaker are turned off. The fan rotates at a very high speed during operation. There is a possibility of injury if the unit's power is accidentally triggered on while cleaning inner parts of the unit.

Service

For repair and maintenance, contact your authorized service dealer.

Controls

• CAUTION

When the air conditioner has been performing its cooling operation and is turned off or set to the fan position, wait at least 3 minutes before resetting to the cooling operation again.

Function

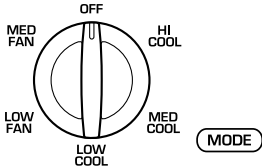
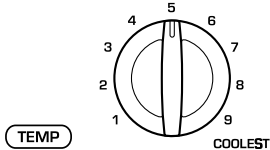
 <p>A circular knob with a vertical slot. The settings are: OFF (top), HI COOL (top-right), MED COOL (right), LOW COOL (bottom), LOW FAN (bottom-left), and MED FAN (top-left). A label 'MODE' is to the right of the knob.</p>	<p>OFF - Turns air conditioner off.</p> <p>MED FAN - Med speed fan operation without cooling.</p> <p>LOW FAN - Low speed fan operation without cooling.</p> <p>HI COOL - Cooling with high speed fan operation.</p> <p>MED COOL - Cooling with med speed fan operation.</p> <p>LOW COOL - Cooling with low speed fan operation.</p>
 <p>A circular knob with a vertical slot and a small arrow pointing to the top. The settings are numbered 1 through 9 around the dial, with 'COOLEST' at the bottom. A label 'TEMP' is to the left of the knob.</p>	<p>This automatically controls the temperature of the indoor air.</p> <p>Turn the knob so that arrow point to the higher number for greater cooling. Point the arrow to the lower number for more moderate cooling. (i.e. the higher number the greater cooling)</p>

• FOR NORMAL COOLING

1. Turn the MODE Knob to the HI COOL from the LOW COOL setting.
2. Set the TEMP control to the desired temperature mark 5 (the mid-point is a good starting position). If the room temperature is not satisfactory after a reasonable time, adjust the control to a cooler or warmer setting, as appropriate.

• FOR MAXIMUM COOLING

1. Turn the MODE Knob to the HI COOL setting.
2. Set the TEMP control to the highest 9 temperature mark.

• FOR QUIETER OPERATION

1. Turn the MODE Knob to the LOW COOL setting.
2. Set the TEMP control as needed.

Additional controls and important information.

Ventilation

The ventilation lever must be in the CLOSE position in order to maintain the best cooling conditions.

When fresh air is necessary in the room, set the ventilation lever to the OPEN position.

The damper is opened and room air is drawn out.

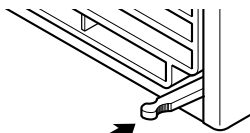

CLOSE ■ VENT ■ OPEN

Air Direction

The direction of air can be controlled wherever you want to cool by adjusting the horizontal louver and the vertical louver.

- **HORIZONTAL AIR-DIRECTION CONTROL**

The horizontal air direction is adjusted by rotating the vertical louver right or left.

- **VERTICAL AIR-DIRECTION CONTROL**

The vertical air direction is adjusted by rotating the horizontal louver forward or backward.

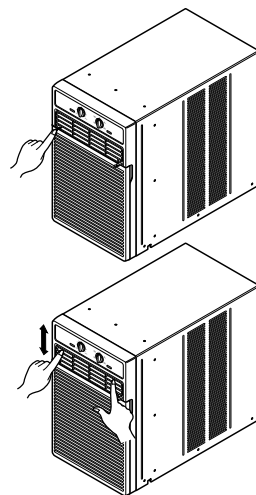

How to Secure the Drain Pipe

In humid weather, excess water may cause the BASE PAN to overflow and be splashed on the side louver. To drain the water, remove the DRAIN CAP and secure the DRAIN PIPE to the rear hole of the BASE PAN.

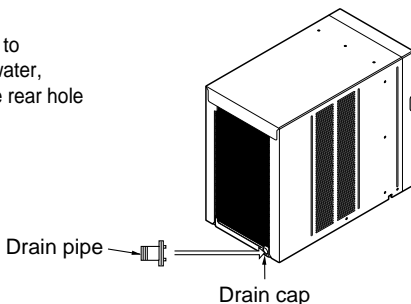

TURN THE AIR CONDITIONER OFF AND REMOVE THE PLUG FROM THE POWER OUTLET.

Air Filter Cleaning

The air filter behind the front grille should be checked and cleaned at least once every 2 weeks or more often if necessary.

To remove:

1. Open the inlet grille downward by pulling out the top of the inlet grille.
2. Remove the air filter from the front grille assembly by pulling the air filter up slightly.
3. Clean the filter with warm, soapy water below 40°C (104°F).
4. Rinse and gently shake the water from the filter and let it dry before replacing it.

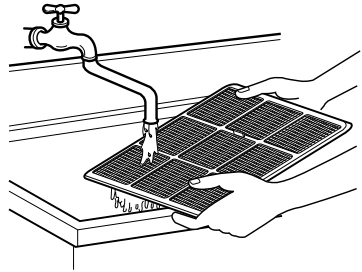
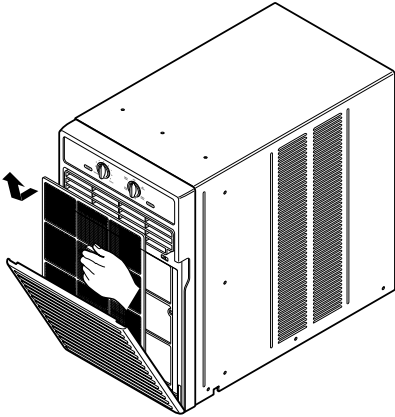

CAUTION: DO NOT operate the air conditioner without a filter because dirt and lint will clog it and reduce performance.

NOTE!

Before using the air conditioner secure the front grille with two screws enclosed with the owner's manual.

1. Open the inlet grille downward and remove the air filter.
2. Fasten the front grille with screws.
3. Reinstall the air filter.
4. Close the inlet grille.

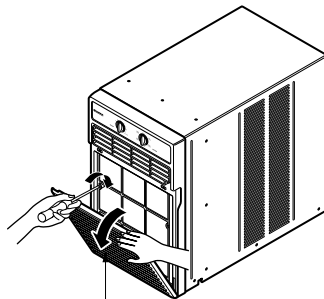

Inlet Grille

Learning parts name prior to installation will help you understand the installation procedure.

Features

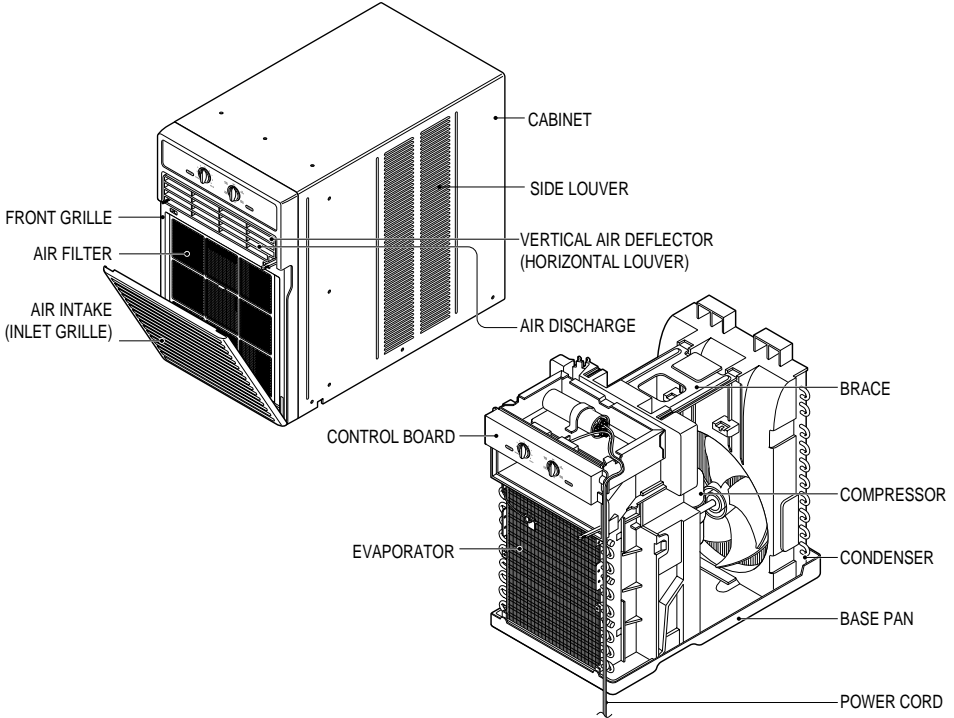

Installing the Power cord

You can choose between the two methods below according to your preference and window sill shape.

Using slit "A"

- Fasten the stopper using Type A screw, and lead out the power cord out through slit "A".

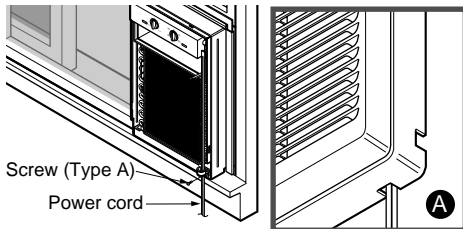

Using slit "B"

- Fasten the stopper using left screw hole, and rotate properly to lead the power cord out through slit "B".

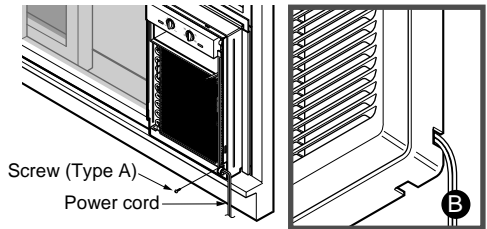

How to Install the Unit

1. To prevent vibration and noise, make sure the unit is installed securely and firmly
2. Install the unit where the sunlight does not shine directly on the unit.
3. The outside of the cabinet must extend outward for at least 14" and there should be no obstacles, such as a fence or wall, within 20" from the back of the cabinet. Restriction of outside air will greatly reduce the cooling efficiency of the air conditioner.

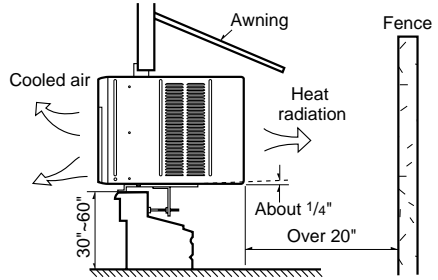

CAUTION: All side louvers of the cabinet must remain exposed to the outside of the structure.

4. Install the unit a little slanted so the back is slightly lower than the front (about 1/4"). This will force condensed water to flow to the outside.
5. Install the unit with the bottom about 30"–60" above the floor level.

Window Requirements

1. These instructions are for a horizontal sliding or a casement window.
2. The electrical outlet must be within reach of the power cord.

For installation in a casement window, the window frame assembly and the side of the building must be adequate to support the weight of the air conditioner.

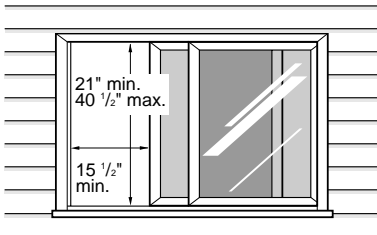

Horizontal sliding window

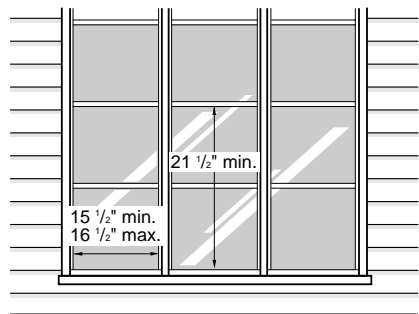

Casement window

Installation Kits Contents

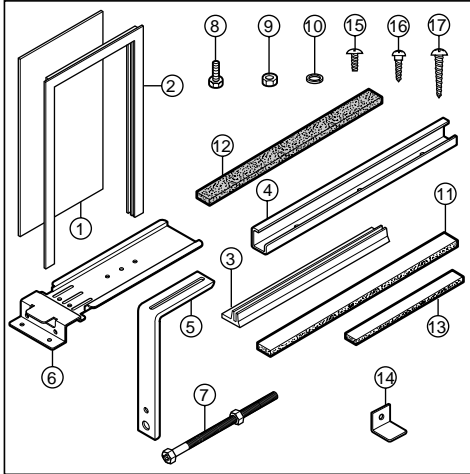

NO.	NAME OF PARTS	Q'TY
1	Curtain	1
2	Curtain Frame	1
3	Upper Guide	1
4	Side Guide	2
5	Support Bracket	1
6	Bracket	1
7	Leveling bolt & nut	1
8	Bolt	2
9	Nut	2
10	Washer	2
11	Side Guide seal	1
12	Foam Seal Strip	1
13	Window Track Seal	1
14	Window Locking Bracket	1
15	Screw (Type A)	9
16	Screw (Type B)	3
17	Screw (Type C)	8

Horizontal Sliding Window Installation

- Loosely attach the Support Bracket to the bottom of Bracket using Bolts, Washer, and Nuts. Attach the Leveling bolt and nut. (Fig. 1)
- Remove protective backing from Window Track Seal and apply seal to window track. (Fig.2)
- Measure and lightly mark a line 8-1/4 inches from window jamb. Center the Support Bracket assembly on the window track and fasten with 4 Type C screws.(Fig. 2)
- Put the Support Bracket against the outside wall and tighten the Bolts on top of the Bracket. Adjust the Leveling Bolt so that the air conditioner will be installed with a very slight tilt (about 1/4") downward toward the outside for proper drainage. Tighten the nut. (Fig. 3)

NOTE: DO NOT drill a hole in the bottom of the base pan. The air conditioner is designed to operate with the bottom of the base pan approximately half-full of water.

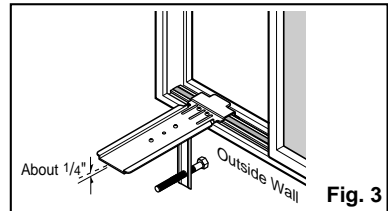
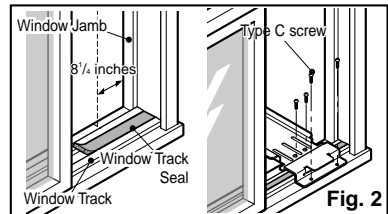
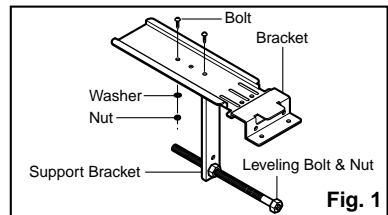

Horizontal Sliding Window Installation

5. Fasten Side Guides to the sides of the Air Conditioner using 3 Type A screws per Guide. Start with first screw at middle of Guide. (Fig. 4)
6. Fasten Upper Guide on the top of the Air Conditioner using 3 Type A screws. (Fig. 4)

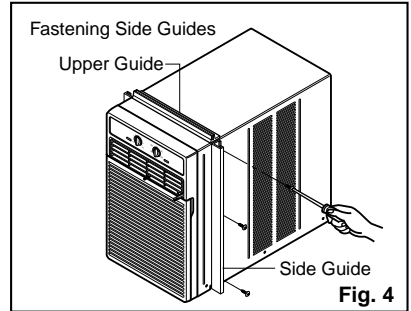

7. Measure height of window opening from top of Bracket assembly as shown Fig. 5. Subtract 20-3/4 inches. Mark this measurement on Curtain and cut the Curtain. (Fig. 5)

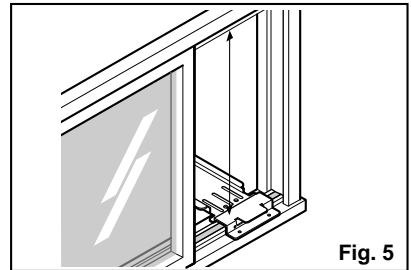

8. Slide Curtain into Curtain Frame. Slide Curtain Frame assembly into side Guides of the Air Conditioner cabinet. Make sure Curtain is firmly enclosed on all sides by the Frame. (Fig. 6)

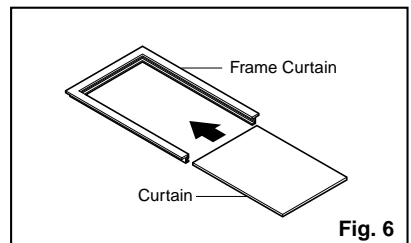

9. Cut side Guide seal into 2 equal lengths. Remove protective backing and apply it to the rear side of cabinet Side Guides, starting just below Curtain Frame assembly. Pinch off excess length so seal is even with the bottom of side Guide. (Fig. 7)

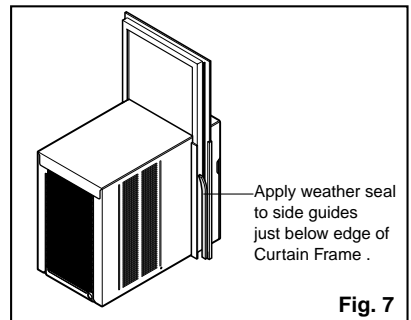

10. Place Air Conditioner in window opening. It should sit on Bracket assembly so that Curtain Frame and cabinet Side Guides are against top and side window jambs. Mate front of Bracket with Base Guide attached to the bottom of base pan.
11. Drill 1/8 inch holes in window track through the existing holes on Base Guide. Screw 4 Type C screws through the holes. (Fig. 8)
12. If this is a casement window installation, proceed to Casement Window Installation. If not, slide inner window sash firmly against side of the cabinet.
13. Drill 1/8 inch hole in window jamb to align with the existing holes in the Curtain Frame. Attach Curtain Frame to window frame with 2 Type B screws. (Fig. 8)

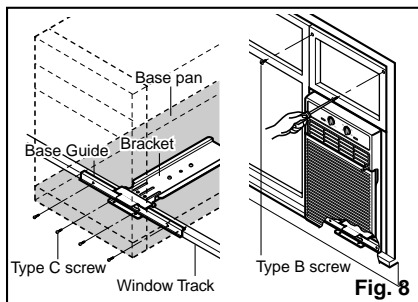

NOTE: Check all seals and plug any remaining air gaps with a suitable weatherproof caulk.

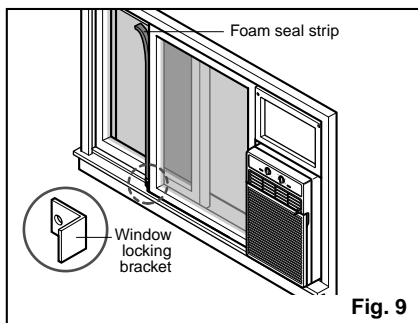

14. If this is a casement window installation, proceed to Casement Window Installation. If not, stuff the Foam Seal Strip between the vertical sash and the window glass. (Fig. 9)
15. Attach the L Bracket with a Type B screw. (Fig. 9)



Casement Window Installation

1. Installation procedure is the same as that described in steps 1 through 11 and step 13 of the Horizontal Sliding Window installation.
2. If the window opening is wider than 15-3/4 inches you will need to install a filler panel. Make this panel from 3/4 inch thick wood and run it the full length of the window. Attach it securely to the window frame and paint it to protect it from the weather.
3. Since styles and sizes of casement windows vary widely, it is advisable to have the air conditioner installed by someone skilled in this type of installation.

Electrical Data

Line Cord Plug	Use Wall Receptacle	Power Supply
 <p>Do not under any circumstances cut or remove the grounding prong from the plug.</p> <p>Power supply cord with 3-prong grounding plug</p>	 <p>Standard 125V, 3-wire grounding receptacle rated 15A, 125V AC</p>	<p>Use 15 AMP, time delay fuse or circuit breaker.</p>

USE OF EXTENSION CORDS

Because of potential safety hazards, we strongly discourage the use of an extension cord. However, if you wish to use an extension cord, use a CSA certified/UL-listed 3-wire (grounding) extension cord, rated 15A, 125V.

Electrical Safety

IMPORTANT (PLEASE READ CAREFULLY)

FOR THE USER'S PERSONAL SAFETY, THIS APPLIANCE MUST BE PROPERLY GROUNDED

The power cord of this appliance is equipped with a three-prong(grounding) plug. Use this with a standard three-slot(grounding) wall power outlet(Fig. 10) to minimize the hazard of electric shock. The customer should have the wall receptacle and circuit checked by a qualified electrician to make sure the receptacle is properly grounded.

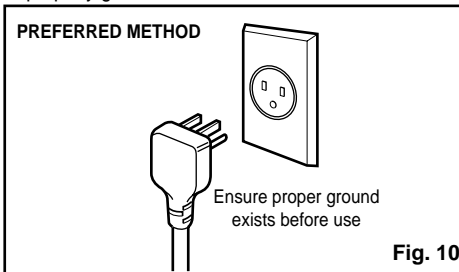

DO NOT CUT OR REMOVE THE THIRD(GROUND) PRONG FROM THE POWER PLUG.

A. SITUATIONS WHERE THE APPLIANCE WILL BE DISCONNECTED ONLY OCCASIONALLY:

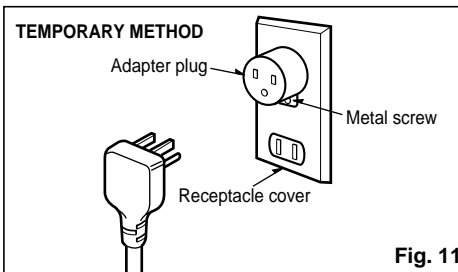

Because of potential safety hazards, we strongly discourage the use of an adapter plug. However, if you wish to use an adapter, a TEMPORARY CONNECTION may be made. Use UL-listed adapter, available from most local hardware store(Fig. 11). The large slot in the adapter must be aligned with the large slot in the receptacle to assure a proper polarity connection.

CAUTION: Attaching the adapter ground terminal to the wall receptacle cover screw does not ground the appliance unless the cover screw is metal, and not insulated, and the wall receptacle is grounded through the house wiring.

The customer should have the circuit checked by a qualified electrician to make sure the receptacle is properly grounded.

Disconnect the power cord from the adapter, using one hand on each. Otherwise, the adapter ground terminal might break. **DO NOT USE** the appliance with a broken adapter plug.

B. SITUATIONS WHERE THE APPLIANCE WILL BE DISCONNECTED OFTEN.

Do not use an adapter plug in these situations. Unplugging the power cord frequently can lead to an eventual breakage of the ground terminal. The wall power outlet should be replaced by a three-slot(grounding) outlet instead.

USE OF EXTENSION CORDS

Because of potential safety hazards, we strongly discourage the use of an extension cord. However, if you wish to use an extension cord, use a CSA certified/UL-listed 3-wire(grounding) extension cord, rated 15A, 125V.

Troubleshooting Tips

Save time and money! Review the chart below first and you may not need to call for service.

Normal Operation

- You may hear a pinging noise caused by water being picked up and thrown against the condenser on rainy days or when the humidity is high. This design feature helps remove moisture and improve efficiency.
- You may hear the thermostat click when the compressor cycles on and off.
- Water will collect in the base pan during high humidity or on rainy days. The water may overflow and drip from the outdoor side of the unit.
- The fan may run even when the compressor does not.

Abnormal Operation

Problem	Possible Causes	What To Do
Air conditioner does not start	■ <i>The air conditioner is unplugged.</i>	• Make sure the air conditioner plug is pushed completely into the outlet.
	■ <i>The fuse is blown/circuit breaker is tripped.</i>	• Check the house fuse/circuit breaker box and replace the fuse or reset the breaker.
	■ <i>Power failure.</i>	• If power failure occurs, turn the mode control to Off . When power is restored, wait 3 minutes to restart the air conditioner to prevent tripping of the compressor overload.
Air conditioner does not cool as it should	■ <i>Airflow is restricted.</i>	• Make sure there are no curtains, blinds, or furniture blocking the front of the air conditioner.
	■ <i>The TEMP Control may not be set high enough.</i>	• Turn the knob to a higher number. The highest setting provides maximum cooling.
	■ <i>The air filter is dirty.</i>	• Clean the filter at least every 2 weeks. See the care and maintenance section.
	■ <i>The room may have been hot.</i>	• When the air conditioner is first turned on you need to allow time for the room to cool down.
	■ <i>Cold air is escaping.</i>	• Check for open furnace floor registers and cold air returns. • Set the air conditioner's vent to the closed position.
	■ <i>Cooling coils have iced up.</i>	• See Air Conditioner Freezing Up below.
Air conditioner freezing up	■ <i>Ice blocks the air flow and stops the air conditioner from cooling the room.</i>	• Set the mode control at High Cool with the high temperature mark 1 or 2.

LIMITED WARRANTY

United States of America

LG Electronics will repair or at its option replace, without charge, your product which proves to be defective in material or workmanship under normal use during the warranty period listed below from the date of original purchase.

This warranty is good only to the original purchaser of the product during the warranty period as long as it is in the U.S including Alaska, Hawaii, and U.S. Territories.

LG Room Air Conditioner Warranty Period

Product	Parts	Labor
All Parts	2 Year	2 Year (In-Home Service)
Compressor	5 Years	2 Year (In-Home Service)

No other express warranty is applicable to this product. THE DURATION OF ANY IMPLIED WARRANTIES, INCLUDING THE IMPLIED WARRANTY OF MERCHANTABILITY, IS LIMITED TO THE DURATION OF THE EXPRESS WARRANTY HEREIN. LG ELECTRONICS SHALL NOT BE LIABLE FOR THE LOSS OF USE OF THE PRODUCT, INCONVIENCE, LOSS OR ANY OTHER DAMAGES, DIRECT OR CONSEQUENTIAL, ARISING OUT OF THE USE OF OR INABILITY TO USE, THIS PRODUCT OR FOR ANY BREACH OF ANY EXPRESS OR IMPLIED WARRANTY, INCLUDING THE IMPLIED WARRANTY OF MERCHANTABILITY APPLICABLE TO THIS PRODUCT.

Some States do not allow the exclusion or limitation of incidental or consequential damages or limitations on how long an implied warranty lasts; so these limitations or exclusions may not apply to you.

This warranty gives you specific legal rights and you may also have other rights which vary from state to state.

THE ABOVE WARRANTY DOES NOT APPLY TO:

1. Service trips to your home to deliver and pickup, install, instruct, or replace house fuses or correct house wiring or plumbing, or correction of unauthorized repairs.
2. Damage to the product caused by accident, pests, fire, floods, or acts of God.
3. Repairs when your LG product is used in other than normal, single-family household use.
4. Damage resulting from accident, alteration, misuse, abuse, or improper installation.

Therefore, these costs are paid by the consumer.

If the product is installed outside the normal service area, any cost of transportation involved in the repair of the product, or the replacement of a defective parts, shall be borne by the owner.

CUSTOMER ASSISTANCE NUMBERS:

To obtain Warranty Coverage:

Retain your Bill of Sales to prove date of purchase.

A Copy of your Sales Receipt must be submitted at the time warranty service is provided.

To obtain Product or Customer Service Assistance:

Call 1-800-243-0000 (Mon.~ Fri. 7 AM ~ 8 PM CT)
(Sat. 8 AM ~ 5 PM CT)

Press the appropriate menu option, and have your product type (Room Air Conditioner), model number, serial number, and ZIP Code ready.

To obtain the nearest Authorized Service Center:

Call 1-800-243-0000 (24 hrs a day, 7 days per week)
Press the appropriate option, and have your product type (Room Air Conditioner), model number, serial number, and ZIP Code ready.